

SEALEVEL®

High Speed 7-Port USB 2.0 Hub with SeaLATCH USB Ports

User Manual



Item# HUB7M

Contents

- Safety Instructions 4
 - Electrostatic Discharges (ESD)..... 4
 - Grounding Methods 4
- Introduction..... 5
 - Features 5
- Before You Get Started..... 6
 - Advisory Conventions 6
 - What’s Included 6
 - Optional Items..... 7
- Installation 8
 - Windows 98/ME/2000/XP/Vista/7™ Operating Systems 8
 - Linux Support 8
- Hardware Description..... 9
 - USB Ports 9
 - Status LEDs 10
 - External Power 10
- SeaLATCH® USB 11
 - SeaLATCH Locking USB Cables 12
- Mounting Options 13
- Technical Specifications 14
 - Power Requirements 14
 - Dimensions..... 14
 - Weight..... 14
 - Environmental Specifications 14
 - Manufacturing 14
- Appendix A - Troubleshooting..... 15
- Appendix B - How To Get Assistance 16
 - Technical Support 16
- Appendix C – Silk Screen – HUB7M PCB 17
- Appendix D – HUB7M Board Mounting Outline..... 18
- Appendix E - Compliance Notices..... 18
 - Federal Communications Commission Statement 19
 - EMC Directive Statement..... 19

Warranty.....	20
Warranty Policy.....	20
Non-Warranty Repair/Retest	20
How to Obtain an RMA (Return Merchandise Authorization)	20
Trademarks	20

Safety Instructions

Electrostatic Discharges (ESD)

A sudden electrostatic discharge can destroy sensitive components. Proper packaging and earthing rules must therefore be observed. Always take the following precautions.

- Transport boards and cards in electrostatically secure containers or bags.
- Keep electrostatically sensitive components in their containers, until they arrive at an electrostatically protected workplace.
- Only touch electrostatically sensitive components when you are properly earthed.
- Store electrostatically sensitive components in protective packaging or on anti-static mats.

Grounding Methods

The following measures help to avoid electrostatic damages to the device:

- Cover workstations with approved antistatic material. Always wear a wrist strap connected to workplace as well as properly grounded tools and equipment.
- Use antistatic mats, heel straps, or air ionizers for more protection.
- Always handle electrostatically sensitive components by their edge or by their casing.
- Avoid contact with pins, leads, or circuitry.
- Turn off power and input signals before inserting and removing connectors or connecting test equipment.
- Keep work area free of non-conductive materials such as ordinary plastic assembly aids and Styrofoam.
- Use field service tools such as cutters, screwdrivers, and vacuum cleaners which are conductive.
- Always place drives and boards PCB-assembly-side down on the foam.

Introduction

The HUB7M is a high speed 7-port USB 2.0 hub that is ideal for adding USB ports to a Seal/O data acquisition “stack” or a Relio R1000 embedded solid-state industrial computer. The HUB7M includes an industrial grade wall-mount power supply that outputs 12VDC @ 2.5A, providing a full 500mA to each attached USB peripheral. Supported in all USB aware operating systems, the HUB7M requires no separate software drivers and is easy to install.

The HUB7M integrates SeaLATCH™ USB ports, which are fully compatible with standard USB cables. When used with the included USB cable with a SeaLATCH type B USB connector, the metal thumbscrew provides a secure metal-to-metal connection to the hub and prevents accidental cable disconnection. The hub’s seven SeaLATCH type A USB connectors can secure USB peripherals to the hub in the same way. Additionally, a highly-retentive type B USB connector helps prevent unintentional separation from a standard USB cable.

Features

- Includes 7 USB downstream ports with 500mA available per port
- SeaLATCH USB connectors provide locking connection
- Status LEDs indicate external power, connection to host, and fault condition
- High-retention USB type “B” connector prevents accidental disconnection of standard USB cable
- USB 2.0 compliant and backwards compatible with USB 1.1 and 1.0 devices
- No drives required for Windows 98SE/ME/2000/XP/Vista/7™ and Linux kernel v2.4 operating systems



Before You Get Started

Advisory Conventions



Warning - The highest level of importance used to stress a condition where damage could result to the product or the user could suffer serious injury.



Important - The middle level of importance used to highlight information that might not seem obvious or a situation that could cause the product to fail.



Note - The lowest level of importance used to provide background information, additional tips, or other non-critical facts that will not affect the use of the product.





What's Included

The HUB7M is shipped with the following items. If any of these items is missing or damaged please contact Sealevel for replacement.

- HUB7M - High Speed 7-Port USB 2.0 Hub with SeaLATCH USB Ports
- CA356 - USB Type A to SeaLATCH USB Type B Cable, 6' in Length
- TR123 - 12VDC @ 2.5A Wall-Mount Power Supply
- Sealevel Software CD - Manual Only

Optional Items

Depending upon your application, you are likely to find one or more of the following cable items useful with the HUB7M. Additional items can be found in the Mounting Options section of this manual. All items can be purchased from our [website](#) or by calling +1 864-843-4343.

SeaLATCH USB Type A and Type B Device Cable, 72" (Item# CA332)	
The CA332 is a USB device cable with SeaLATCH USB type A and type B connectors. The metal thumbscrew on each connector provides a secure metal-to-metal connection to devices with SeaLATCH USB ports.	
SeaLATCH USB Type A to USB Type B Device Cable, 72" (Item# CA355)	
The CA355 is a USB device cable with a SeaLATCH USB type A connector and standard type B connector. This cable secures the HUB7M to legacy USB peripheral devices.	
USB Type A to SeaLATCH Type B Device Cable, 72" (Item# CA356)	
The CA356 is a USB device cable with a SeaLATCH USB type B connector and standard type A connector. This cable is included with all Sealevel USB products with an integrated SeaLATCH type B USB port.	
USB Type A to USB Type A, 3 Meter Extension Cable (Item# CA214)	
The CA214 is a fully rated USB extension cable that adds three meters to any existing USB cable (maximum 5 meters). The CA214 has a type A male connector on one end and a type A female connector on the other end.	
USB Type A to USB Type B, 72" Device Cable (Item# CA179)	
The CA179 is a 72" USB device cable that connects USB peripherals with a Type B connector to the Type A connector on a host computer. The CA179 is USB 2.0 compliant and is compatible with USB 1.1 and 1.0 devices.	
USB Type A to USB Type B, 5 Meter Device Cable (Item# CA215)	
The CA215 is a fully rated 5 meter device cable that connects USB peripherals with a type B connector to the type A connector on a host PC. This cable provides the maximum 5 meters (16 feet) for a USB connection.	

Installation

Windows 98/ME/2000/XP/Vista/7™ Operating Systems

1. The HUB7M is fully supported as a generic USB hub device in Windows 98/ME/2000/XP/Vista/7™ operating systems and requires no separate driver. The Sealevel Software CD is included only for distribution of the user manual and other literature.
2. Simply connect the included wall-mount power supply to the HUB7M and connect to an AC outlet. When the unit is successfully powered, the green LED will light.
3. Using the included SeaLATCH USB device cable, plug the HUB7M into an available USB port on your host system.
4. The 'Found New Hardware' screen will appear and the hub will be automatically recognized as a generic USB hub device. When the unit is successfully recognized by the operating system, the yellow LED will light. During data transfers, this light will blink.
5. The hub is ready to use when you see the screen 'Your USB hub is installed and ready to use.'



Windows NT is not USB aware and thus cannot support this device.

Linux Support

USB devices are supported in Linux kernel v2.4 or better. Refer to the help files included with your Linux distribution for specific instructions on adding generic USB hub devices.

Hardware Description

USB Ports

The HUB7M integrates SeaLATCH USB ports, which are fully compatible with standard USB cables. When used with the included USB cable with a SeaLATCH type B USB connector, the metal thumbscrew provides a secure metal-to-metal connection to the hub and prevents accidental cable disconnection.

Additionally, a highly-retentive type B USB connector helps prevent unintentional separation from a standard USB cable. The SeaLATCH type B locking connector and high retention type B port are shown below.



The hub's seven SeaLATCH type A locking USB connectors can secure USB peripherals to the hub in the same way. Two of the SeaLATCH type A USB ports are shown below. Each of the seven downstream type A USB ports provides a full 500mA to USB peripherals.



Status LEDs

Status LEDs are also included on the front of the HUB7M module to indicate the following information:

- **ENABLE** (Yellow) – Lights when the USB hub is enumerated by the host system.
- **FAULT** (Red) – Lights when there is a problem with a downstream USB port.
Disconnect the downstream devices one at a time until the status returns to normal.
- **EXT POWER** (Green) – Indicates the external power supply is properly connected to the hub and an AC power source.



External Power

The HUB7M includes an industrial grade wall-mount power supply (Item# TR123) that outputs 12VDC @ 2.5A. Power is input via a 5mm 2-position removable screw terminal block (shown below). To prevent accidental disruption of power, the terminal block includes captive mounting screws for securing to the hub.



SeaLATCH® USB

The HUB7M integrates SeaLATCH USB ports, which are fully compatible with standard USB cables. When used with the included USB cable (Item# [CA356](#)) with a SeaLATCH USB type B connector, the metal thumbscrew provides a secure metal-to-metal connection to the hub and prevents accidental cable disconnection.

The hub's seven SeaLATCH type A USB connectors can secure USB peripherals to the hub in the same way. Sealevel incorporates SeaLATCH locking USB ports on many USB I/O devices. Accidental cable disconnection is the most common point of failure with USB industrial I/O devices and SeaLATCH cables and connectors prevents that while being fully compatible with standard USB cables.

Examples of the HUB7M with SeaLATCH equipped Sealevel I/O devices are shown below:

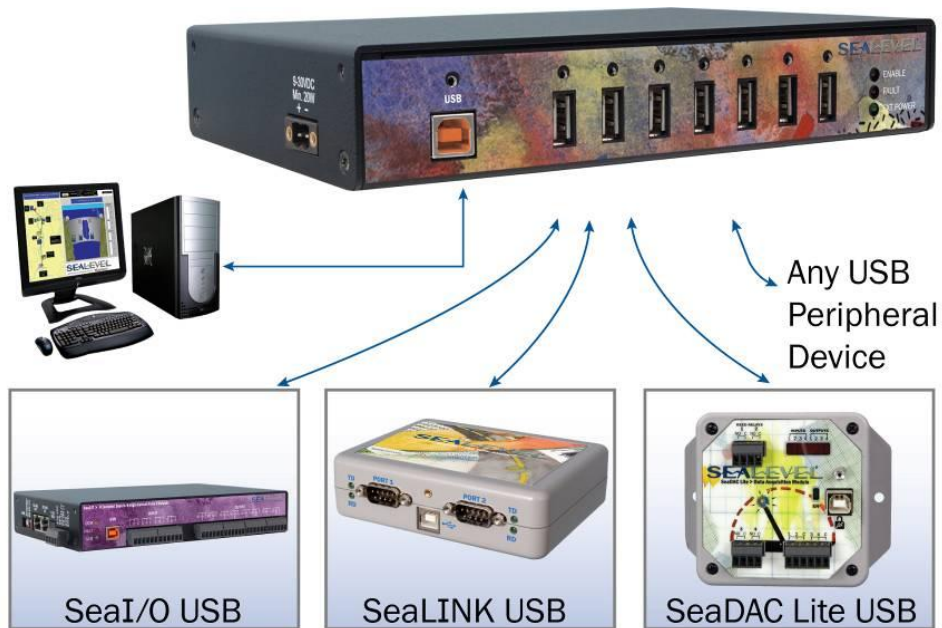

SeaLATCH Locking USB Cables



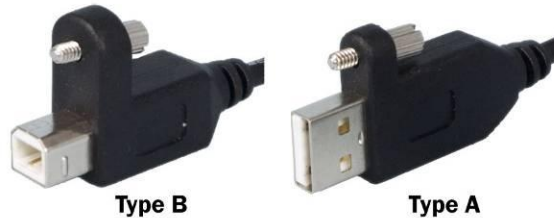

SeaLATCH locking USB cables integrate a small thumbscrew into each USB connector. SeaLATCH USB cables are fully interchangeable with standard USB cables. The thumbscrew provides a secure metal-to-metal connection preventing accidental disconnection. SeaLATCH USB cables are available in three configurations.

SeaLATCH USB Connectors



USB Type A to SeaLATCH USB Type B Device Cable, 72 in Length (Item# CA356)	
<p>The CA356 is a 72" USB cable with a SeaLATCH type B connector and a standard USB type A connector. This cable provides a secure connection between Sealevel products with a SeaLATCH type B port and legacy USB type A ports. The CA356 is included with Sealevel devices with a SeaLATCH type B port.</p>	
SeaLATCH USB Type A to SeaLATCH USB Type B Device Cable, 72 in Length (Item# CA332)	
<p>The CA332 is a 72" cable with both SeaLATCH type A and B connectors. This cable secures both ends of the cable to devices with SeaLATCH USB ports and offers complete protection against accidental cable disconnection.</p>	
SeaLATCH USB Type A to USB Type B Device Cable, 72 in Length (Item# CA355)	
<p>The CA355 is a 72" cable with a standard USB type B and a SeaLATCH type A connector. This cable provides a secure connection between legacy USB devices and Sealevel products with a SeaLATCH type A port, such as the isolated USB hub (Item# 270U).</p>	

Mounting Options

Seal/O Mounting Kit	
<p>The HUB7M is ideal for adding USB ports to a Relio R1000 embedded solid-state industrial computer (as shown), SeaPAC touchscreen HMI system, or a Seal/O data acquisition “stack”. Order the expansion kit (Item# KT122) that includes four metal straps and four #4-40 metal screws.</p>	
DIN Rail Mounting	
<p>The HUB7M is available with a factory-installed DIN-rail mounting clip. Alternatively DIN-rail mounting clips can be ordered as a field upgrade kit (Item# DR104). The bracket with clip is easily attached using two included #4-40 Phillips head machine screws.</p>	
Table/Wall Mounting	
<p>The flush mount bracket kit (Item# KT123) is extremely versatile and can be used to mount the HUB7M from the top, bottom, or back edge. The hub alone or with a stack of Seal/O modules can be mounted flat to a tabletop, underneath a counter, or inside an enclosure. The kit can be used to mount the hub flat to a wall, or along the back edge, similar to DIN-rail mounting options.</p>	
Universal Mounting Bracket	
<p>The universal mounting bracket (Item# KT125) can be used as a “backpack” to other USB peripheral devices to the HUB7M. The universal arrangement of slots and holes accept bolt sizes to M4 and can be used for virtually any mounting configuration. The bracket also has holes for both 75mm and 100mm VESA mounting options.</p>	

Technical Specifications

Power Requirements

9-30 VDC @ 20W

Dimensions

Length	Width	Height
7.5"	5.1"	1.3"
19.05cm	12.95cm	3.30cm

Weight

1.0 lbs/ .46 kg

Environmental Specifications

Specification	Operating	Storage
Temperature Range	0°C - 70°C (32°F - 158°F)	-50°C - 105°C (-58°F - 221°F)
Humidity Range	10 to 90% R.H. Non-Condensing	10 to 90% R.H. Non-Condensing

Manufacturing

All Sealevel Systems Printed Circuit boards are built to UL 94V0 rating and are 100% electrically tested. These printed circuit boards are solder mask over bare copper or solder mask over tin nickel.

Appendix A - Troubleshooting

The HUB7M is a generic USB hub and should provide years of trouble-free service. Should the device appear to not be functioning correctly, the following tips can eliminate most common problems without the need to call Technical Support.

1. Make sure the power supply is connected to the hub and to a live AC power outlet. The green LED on the front of the unit will be lit, indicating the hub is properly powered. Inspect the power supply or call for a replacement if the green LED does not light after connecting to power.
2. Make sure the hub is connected to a USB port using the included USB cable or quality replacement USB cable. The yellow LED will be lit when the hub is properly enumerated by the operating system.
3. The hub is supported in any USB aware operating system that supports generic USB hub devices, including Windows 98/ME/2000/XP/Vista/7™ operating systems and Linux (kernel v2.4 or better). Check to make sure that USB support is enabled in the System BIOS and it is functioning properly in the operating system. This can be done by using Device Manager in Windows.
4. If the red LED lights, there is a fault condition with one of the downstream USB ports. When a downstream USB peripheral pulls more than 500mA of power, the over current protection current will shut down the hub until the problem is resolved.
5. Disconnect your USB peripherals one at a time until the red LED goes out. Inspect the problem USB peripheral and replace, if necessary. Try connecting a different USB peripheral to the problem port. If the red LED lights on the same USB port with a different device, contact technical support for further assistance.

If these steps do not solve your problem, please call Sealevel's Technical Support at +1 864-843-4343. Our technical support is free and available from 8:00 AM to 5:00 PM Eastern Time Monday through Friday. For email support, contact support@sealevel.com.

Appendix B - How To Get Assistance

When calling for technical assistance, please have the device installed and ready to run diagnostics. If possible, have your user manual and current settings ready.

The Sealevel website is an excellent resource. The most current software updates and user manuals are available via our homepage by clicking on the 'Drivers' or 'Manuals' links located under 'Technical Support.' Manuals and software can also be downloaded from the product page for your device.

The FAQ section of our website answers many common questions. Refer to this helpful resource by visiting <http://www.sealevel.com/faq.asp>.

Technical Support

Monday - Friday

8:00 am to 5:00 pm EST

Phone: +1 (864) 843-4343

Email: support@sealevel.com

Web: www.sealevel.com

RETURN AUTHORIZATION MUST BE OBTAINED FROM SEALEVEL SYSTEMS, INC. BEFORE RETURNED MERCHANDISE WILL BE ACCEPTED. AUTHORIZATION CAN BE OBTAINED BY CALLING SEALEVEL AND REQUESTING A RETURN MERCHANDISE AUTHORIZATION (RMA) NUMBER.

Appendix C - Silk Screen - HUB7M PCB

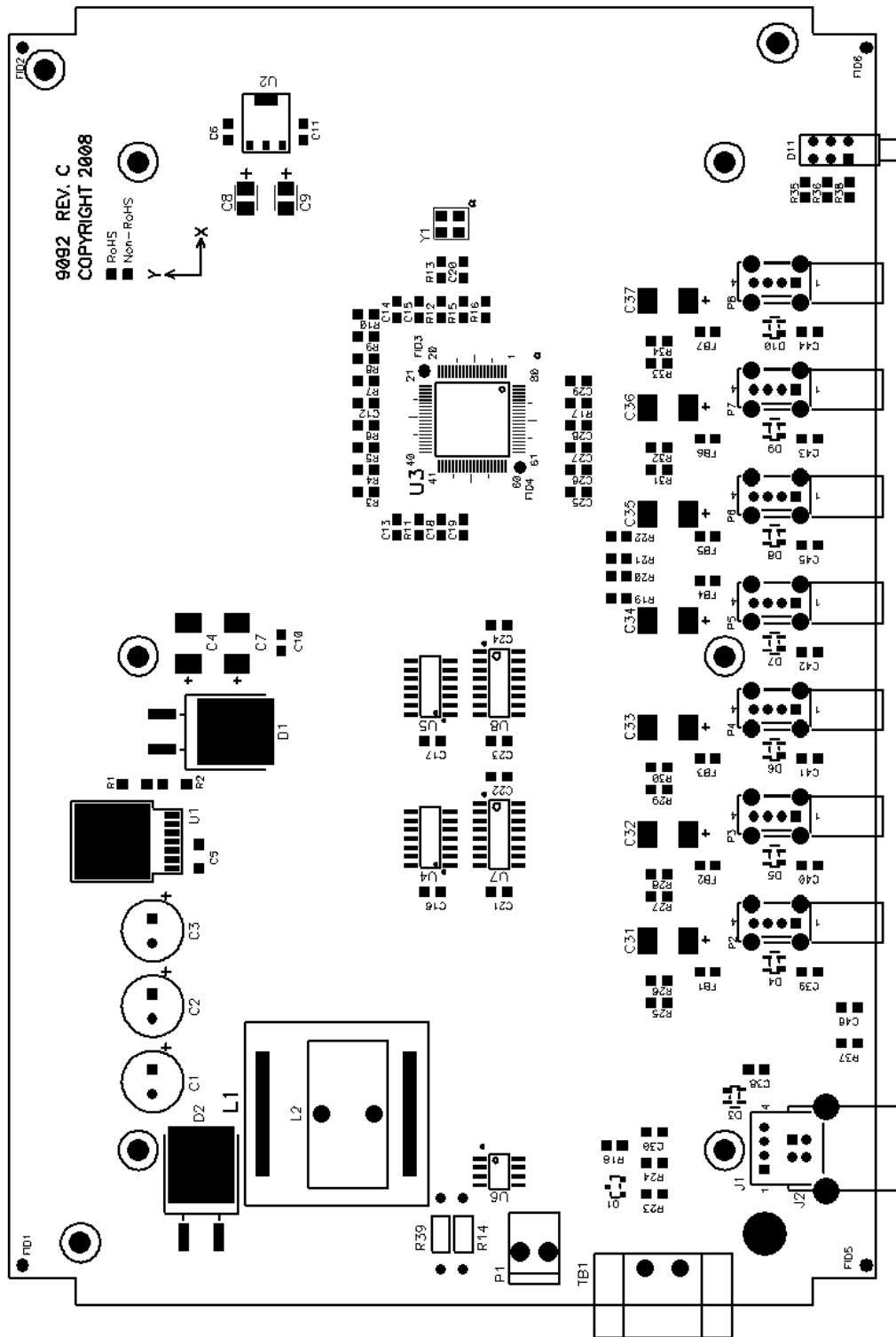

Appendix D - HUB7M Board Mounting Outline

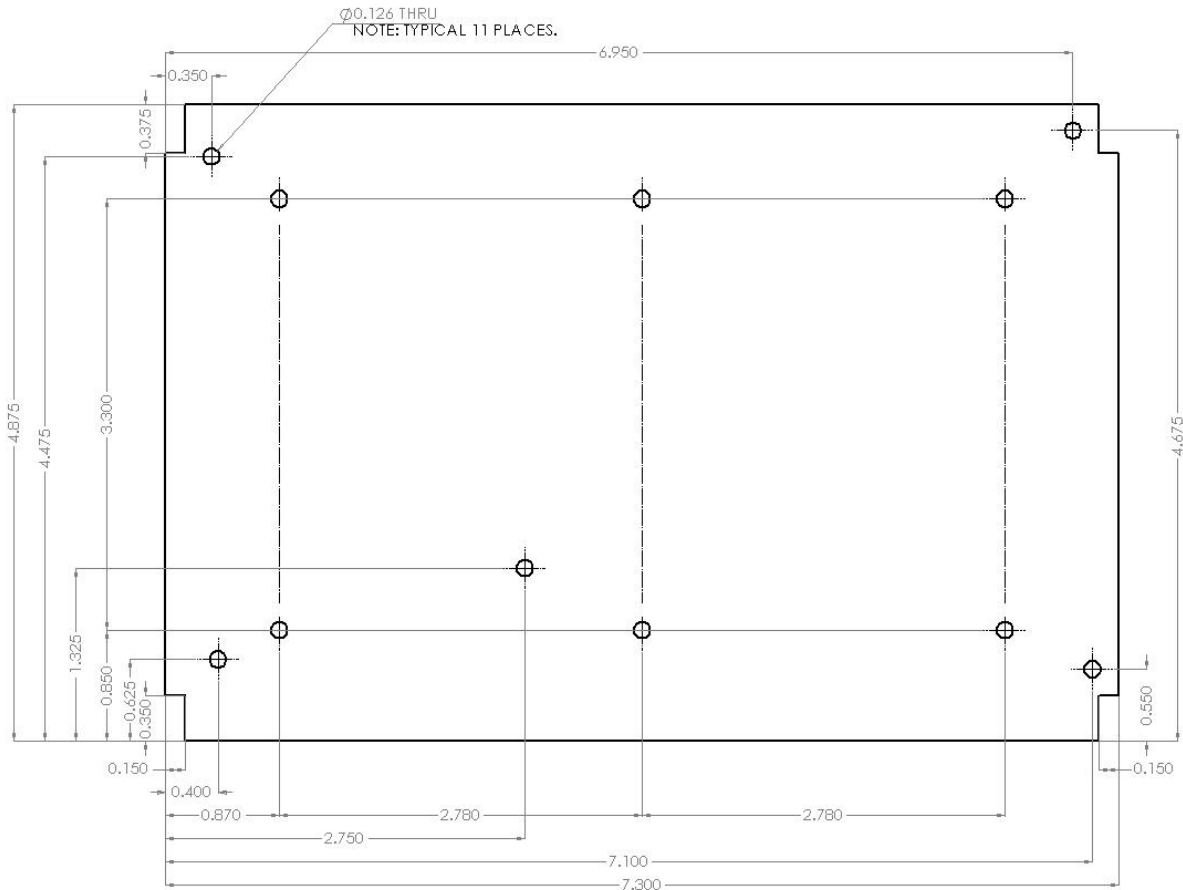

Appendix E - Compliance Notices

Federal Communications Commission Statement

FCC - This equipment has been tested and found to comply with the limits for Class A digital device, pursuant to Part 15 of the FCC Rules. These limits are designed to provide reasonable protection against harmful interference when the equipment is operated in a commercial environment. This equipment generates, uses, and can radiate radio frequency energy and, if not installed and used in accordance with the instruction manual, may cause harmful interference to radio communications. Operation of this equipment in a residential area is likely to cause harmful interference in such case the user will be required to correct the interference at the users expense.

EMC Directive Statement



Products bearing the CE label fulfill the requirements of the EMC directive (89/336/EEC) and of the low-voltage directive (73/23/EEC) issued by the European Commission.

To obey these directives, the following European standards must be met:

EN55022 Class A - "Limits and methods of measurement of radio interference characteristics of information technology equipment"

EN55024 - "Information technology equipment Immunity characteristics Limits and methods of measurement".

EN60950 (IEC950) - "Safety of information technology equipment, including electrical business equipment"



This is a Class A Product. In a domestic environment, this product may cause radio interference in which case the user may be required to take adequate measures to prevent or correct the interference.

Always use cabling provided with this product if possible. If no cable is provided or if an alternate cable is required, use high quality shielded cabling to maintain compliance with FCC/EMC directives.

Warranty

Sealevel's commitment to providing the best I/O solutions is reflected in the Lifetime Warranty that is standard on all Sealevel manufactured I/O products. Relio™ industrial computers are warranted for a period of two years and the R9 family is warranted for a five year period from date of purchase. We are able to offer this warranty due to our control of manufacturing quality and the historically high reliability of our products in the field. Sealevel products are designed and manufactured at its Liberty, South Carolina facility, allowing direct control over product development, production, burn-in and testing. Sealevel achieved ISO-9001:2000 certification in 2002.

Warranty Policy

Sealevel Systems, Inc. (hereafter "Sealevel") warrants that the Product shall conform to and perform in accordance with published technical specifications and shall be free of defects in materials and workmanship for the warranty period. In the event of failure, Sealevel will repair or replace the product at Sealevel's sole discretion. Failures resulting from misapplication or misuse of the Product, failure to adhere to any specifications or instructions, or failure resulting from neglect, abuse, accidents, or acts of nature are not covered under this warranty.

Warranty service may be obtained by delivering the Product to Sealevel and providing proof of purchase. Customer agrees to insure the Product or assume the risk of loss or damage in transit, to prepay shipping charges to Sealevel, and to use the original shipping container or equivalent. Warranty is valid only for original purchaser and is not transferable.

This warranty applies to Sealevel manufactured Product. Product purchased through Sealevel but manufactured by a third party will retain the original manufacturer's warranty.

Non-Warranty Repair/Retest

Products returned due to damage or misuse and Products retested with no problem found are subject to repair/retest charges. A purchase order or credit card number and authorization must be provided in order to obtain an RMA (Return Merchandise Authorization) number prior to returning Product.

How to Obtain an RMA (Return Merchandise Authorization)

If you need to return a product for warranty or non-warranty repair, you must first obtain an RMA number. Please contact Sealevel Systems, Inc. Technical Support for assistance:

Available	Monday – Friday, 8:00AM to 5:00PM EST
Phone	864-843-4343
Email	support@sealevel.com

Trademarks

Sealevel Systems, Incorporated acknowledges that all trademarks referenced in this manual are the service mark, trademark, or registered trademark of the respective company.